

SPECIFICATION FOR APPROVAL

Package Dimensions

Material's Picture

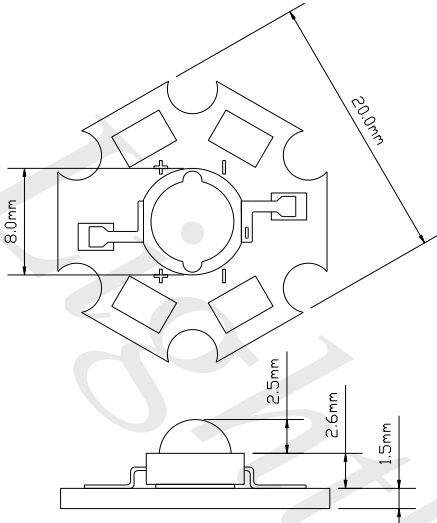

Notes

1. All dimensions are in millimeters (inches).
2. Tolerance is $\pm 0.25\text{mm}$ (0.010") unless otherwise noted.
3. Protruded resin under flange is 1.0mm (0.04") max.
4. Lead spacing is measured where the leads emerge from the package.
5. Specifications are subject to change without notice.

Spatial Distribution

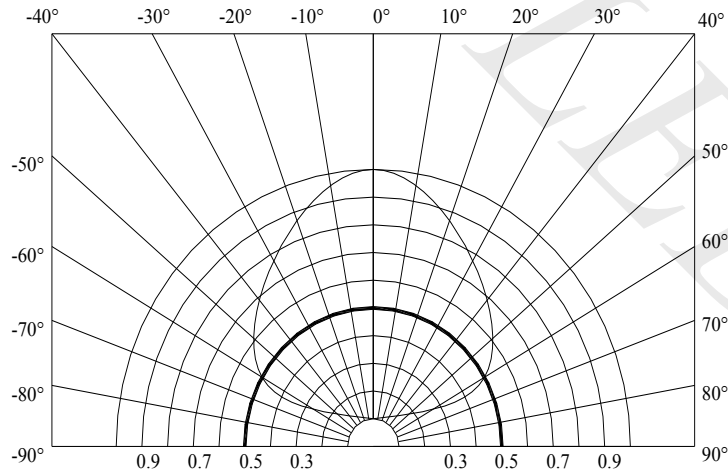

PART NUMBER	REV	PAGE	DATE
A-1PWUGCD	R101	1/4	2011-05-23

SPECIFICATION FOR APPROVAL

Electrical / Optical Characteristics at TA=25°C

Parameter	Symbol	Min.	Typ.	Max.	Unit	Test Condition
Luminous Intensity	Φ	80	90	100	lm	IF =350mA
Viewing Angle	$2\theta 1/2$		140		deg	IF =350mA
Domain Wavelength	Tc				K	IF =350mA
Spectral Line Half-Width	$\Delta \lambda$	520	525	530	nm	IF =350mA
Forward Voltage	VF	3.20	3.30	3.40	V	IF =350mA
Reverse Current	IR			20	μ A	VR = 5V

Absolute Maximum Ratings at TA=25°C

Parameter	Maximum Rating
Power Dissipation	1W
Peak Forward Current (1/10 Duty Cycle, 0.1ms Pulse Width)	450mA
Continuous Forward Current	350mA
Derating Linear From 30°C	0.8mA/°C
Reverse Voltage	5V
Operating Temperature Range	-20°C to + 80°C
Storage Temperature Range	-30°C to + 100°C
Lead Soldering Temperature [1.6mm(.063") From Body]	260°C for 5 Seconds

PART NUMBER	REV	PAGE	DATE
A-1PWUGCD	R101	2/4	2011-05-23

SPECIFICATION FOR APPROVAL

Chromaticity Coordinate Groups



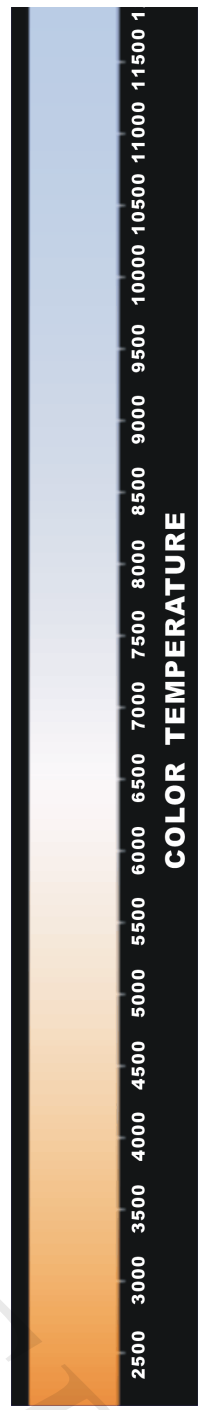
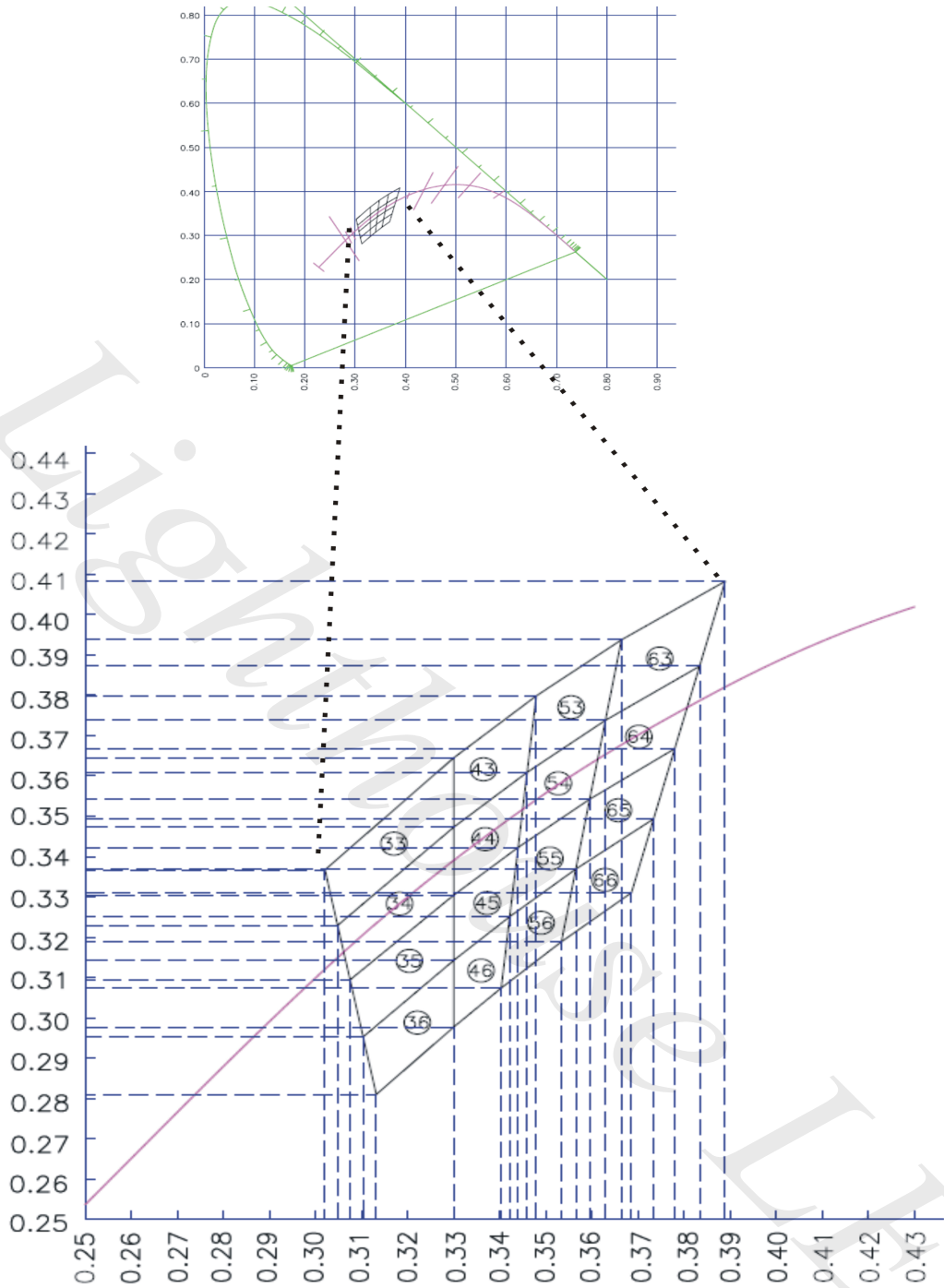

PART NUMBER	REV	PAGE	DATE
A-1PWUGCD	R101	3/4	2011-05-23

SPECIFICATION FOR APPROVAL

HIGH POWER LED Typical Electro-Optical Characteristics Curves

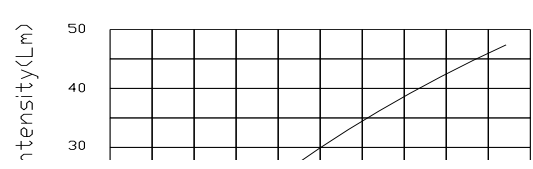
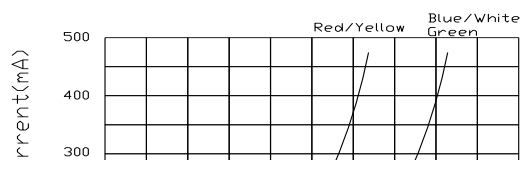

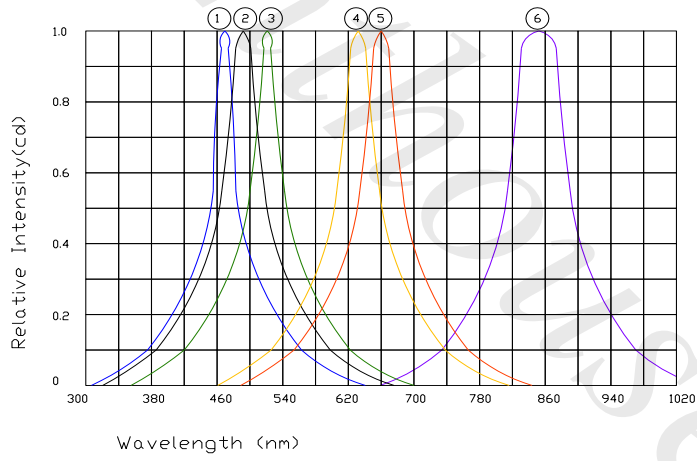
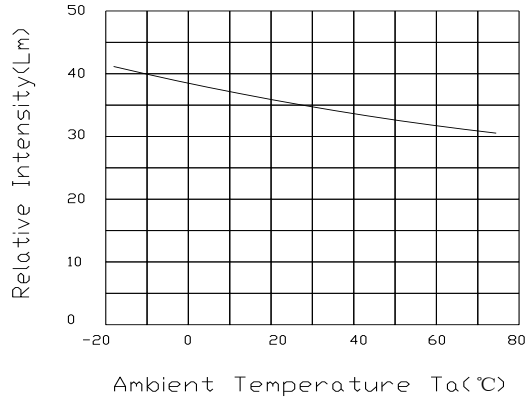
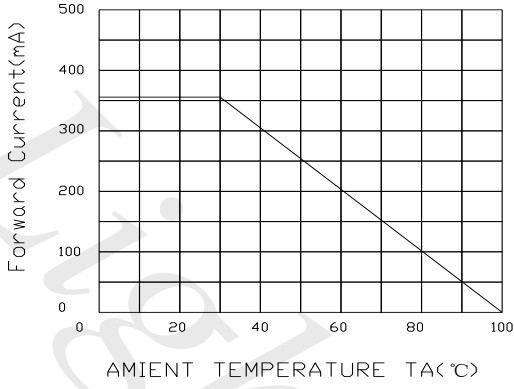
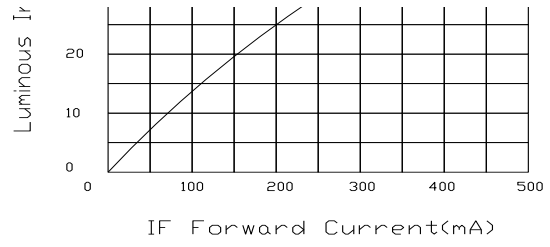
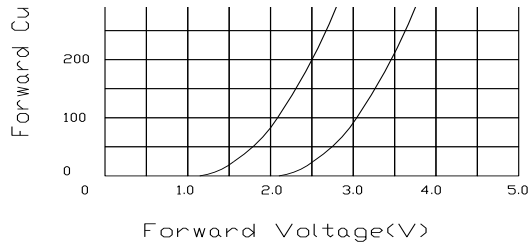

- ① Blue Lamp(InGaN)
- ② White Lamp(InGaN)
- ③ Pure Green Lamp(InGaN)
- ④ Yellow Green Lamp(AlInGaP)
- ⑤ Red Lamp(AlInGaP)
- ⑥ Infrared Lamp(850nm)

PART NUMBER	REV	PAGE	DATE
A-1PWUGCD	R101	4/4	2011-05-23