

SPECIFICATION FOR APPROVAL

Package Dimensions

Material's Picture

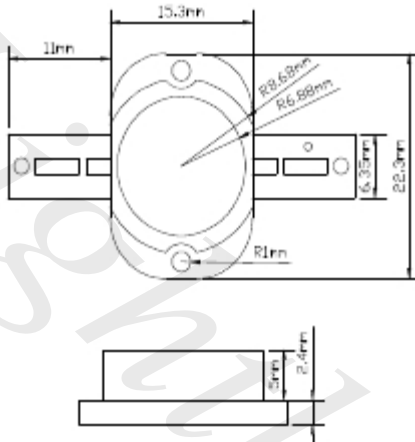

Notes

1. All dimensions are in millimeters (inches).
2. Tolerance is $\pm 0.25\text{mm}$ ($0.010''$) unless otherwise noted.
3. Protruded resin under flange is 1.0mm ($0.04''$) max.
4. Lead spacing is measured where the leads emerge from the package.
5. Specifications are subject to change without notice.

Spatial Distribution

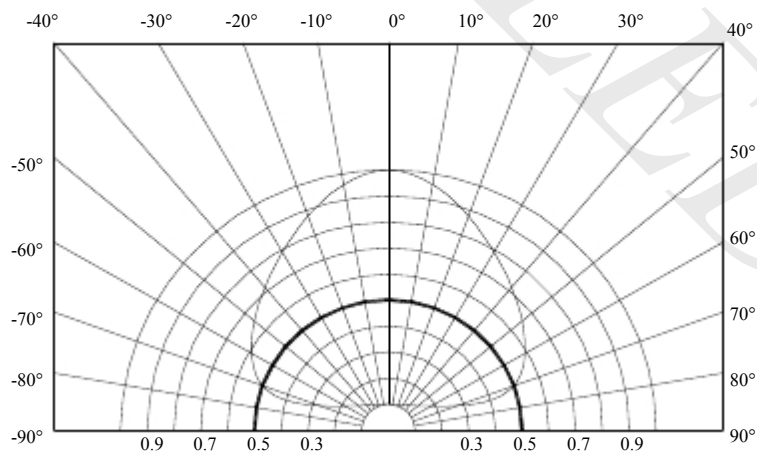

PART NUMBER	REV	PAGE	DATE
WX-P20WW6510B10600	R101	1/4	2008-12-20

SPECIFICATION FOR APPROVAL

Electrical / Optical Characteristics at TA=25°C

Parameter	Symbol	Min.	Typ.	Max.	Unit	Test Condition
Luminous Intensity	Φ	600	650	700	lm	IF =900mA
Viewing Angle	2 θ 1/2		140		deg	IF =900mA
Domain Wavelength	Tc	6000	6500	7000	K	IF =900mA
Spectral Line Half-Width	$\Delta\lambda$				nm	IF =900mA
Forward Voltage	VF	10.00	10.50	11.00	V	IF =900mA
Reverse Current	IR			20	μ A	VR = 5V

Absolute Maximum Ratings at TA=25°C

Parameter	Maximum Rating
Power Dissipation	10W
Peak Forward Current (1/10 Duty Cycle, 0.1ms Pulse Width)	900mA
Continuous Forward Current	2000MA
Derating Linear From 30°C	0.8mA/°C
Reverse Voltage	5V
Operating Temperature Range	30°C to + 60°C
Storage Temperature Range	-30°C to + 60°C
Lead Soldering Temperature [1.6mm(.063") From Body]	260°C for 5 Seconds

PART NUMBER	REV	PAGE	DATE
WX-P20WW6510B10600	R101	2/4	2008-12-20

SPECIFICATION FOR APPROVAL

Chromaticity Coordinate Groups

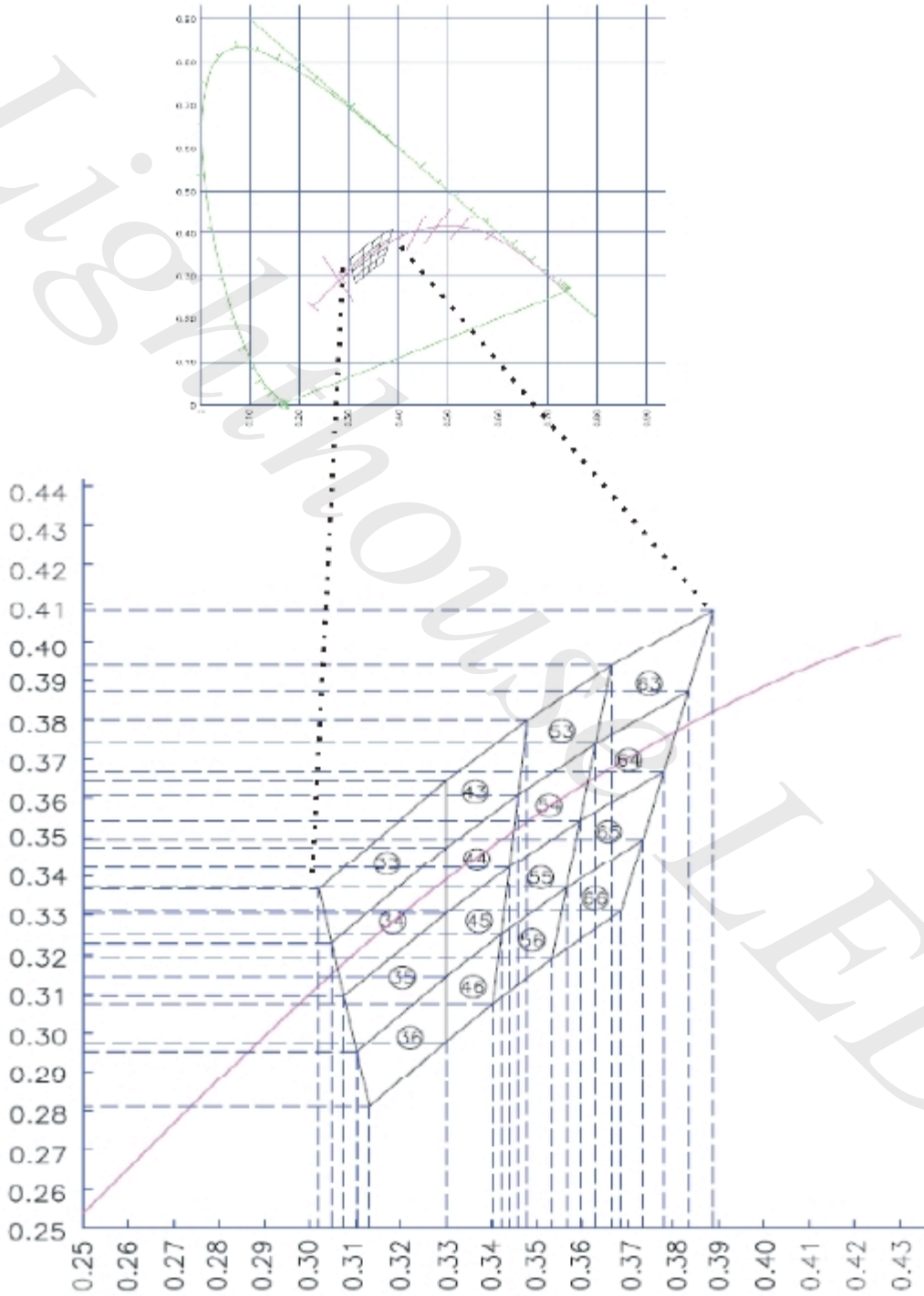

PART NUMBER	REV	PAGE	DATE
WX-P20WW6510B10600	R101	3/4	2008-12-20

SPECIFICATION FOR APPROVAL

HIGH POWER LED Typical Electro-Optical Characteristics Curves

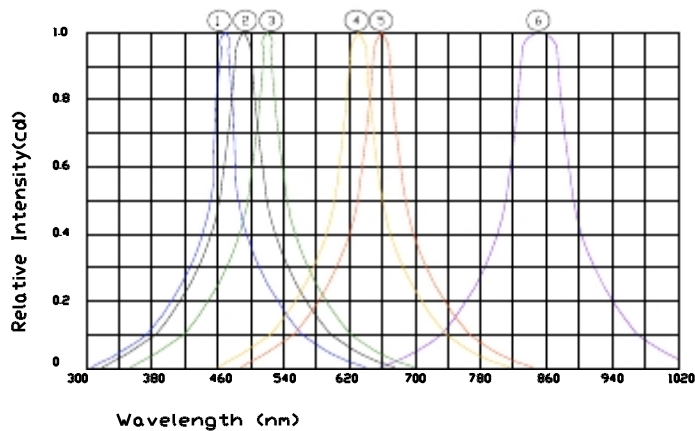
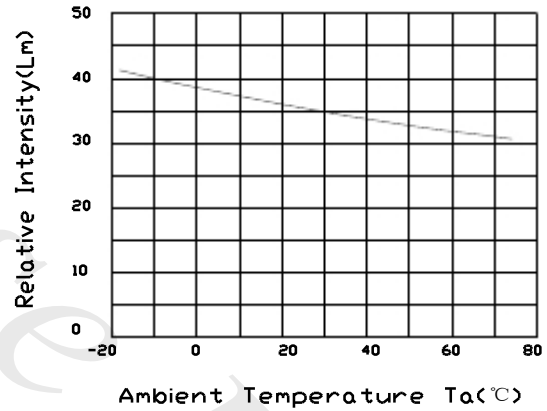
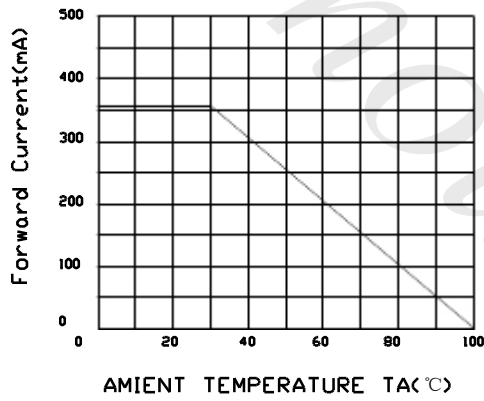
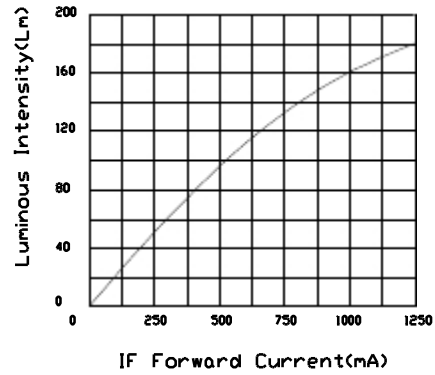
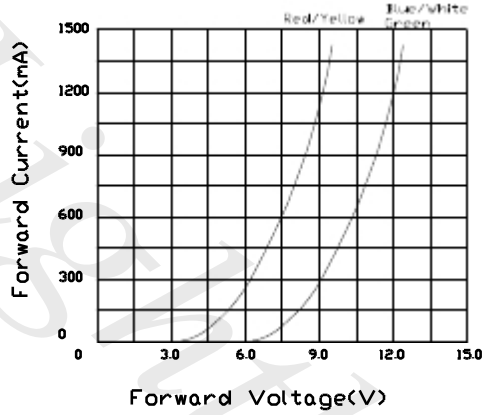

- ① Blue Lamp(InGaN)
- ② White Lamp(InGaN)
- ③ Pure Green Lamp(InGaN)
- ④ Yellow Green Lamp(AlInGaP)
- ⑤ Red Lamp(AlInGaP)
- ⑥ Infrared Lamp(850nm)

PART NUMBER	REV	PAGE	DATE
WX-P20WW6510B10600	R101	4/4	2008-12-20