

SPECIFICATION FOR APPROVAL

Package Dimensions

Material's Picture

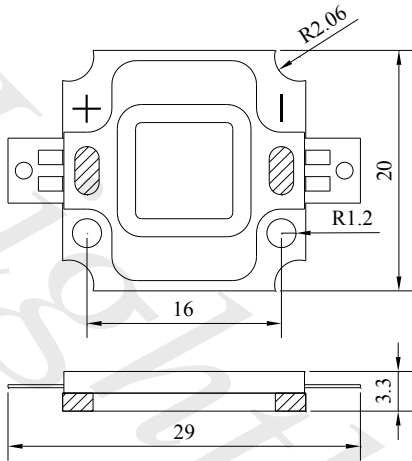

Notes

1. All dimensions are in millimeters (inches).
2. Tolerance is $\pm 0.25\text{mm}$ ($0.010''$) unless otherwise noted.
3. Protruded resin under flange is 1.0mm ($0.04''$) max.
4. Lead spacing is measured where the leads emerge from the package.
5. Specifications are subject to change without notice.

Spatial Distribution

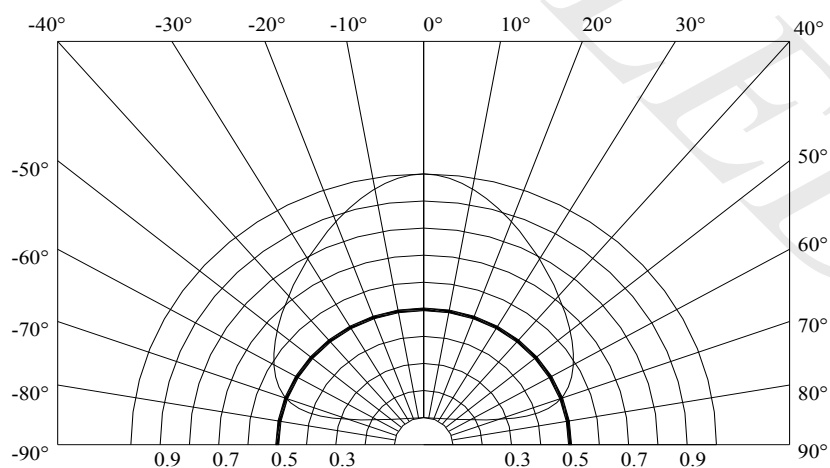

PART NUMBER	REV	PAGE	DATE
XH-P20WB539B10	R101	1/4	2010-09-21

SPECIFICATION FOR APPROVAL

Electrical / Optical Characteristics at TA=25°C

Parameter	Symbol	Min.	Typ.	Max.	Unit	Test Condition
Luminous Intensity	Φ	200	250	300	lm	IF =1050mA
Viewing Angle	2θ 1/2		140		deg	IF =1050mA
Domain Wavelength	Tc				K	IF =1050mA
Spectral Line Half-Width	$\Delta\lambda$	460	462	465	nm	IF =1050mA
Forward Voltage	VF	9.00	10.00	11.00	V	IF =1050mA
Reverse Current	IR			20	μ A	VR = 5V

Absolute Maximum Ratings at TA=25°C

Parameter	Maximum Rating
Power Dissipation	10W
Peak Forward Current (1/10 Duty Cycle, 0.1ms Pulse Width)	1050mA
Continuous Forward Current	1500mA
Derating Linear From 30°C	0.8mA/°C
Reverse Voltage	5V
Operating Temperature Range	-20°C to + 60°C
Storage Temperature Range	-35°C to + 60°C
Lead Soldering Temperature [1.6mm(.063") From Body]	300°C for 5 Seconds

PART NUMBER	REV	PAGE	DATE
XH-P20WB539B10	R101	2/4	2010-09-21

SPECIFICATION FOR APPROVAL

Chromaticity Coordinate Groups

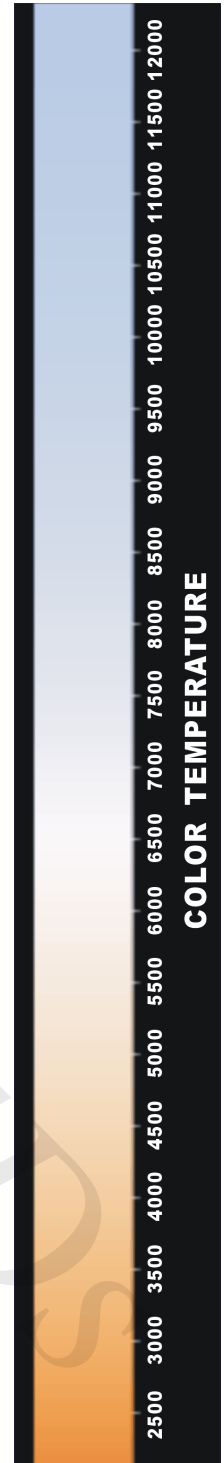
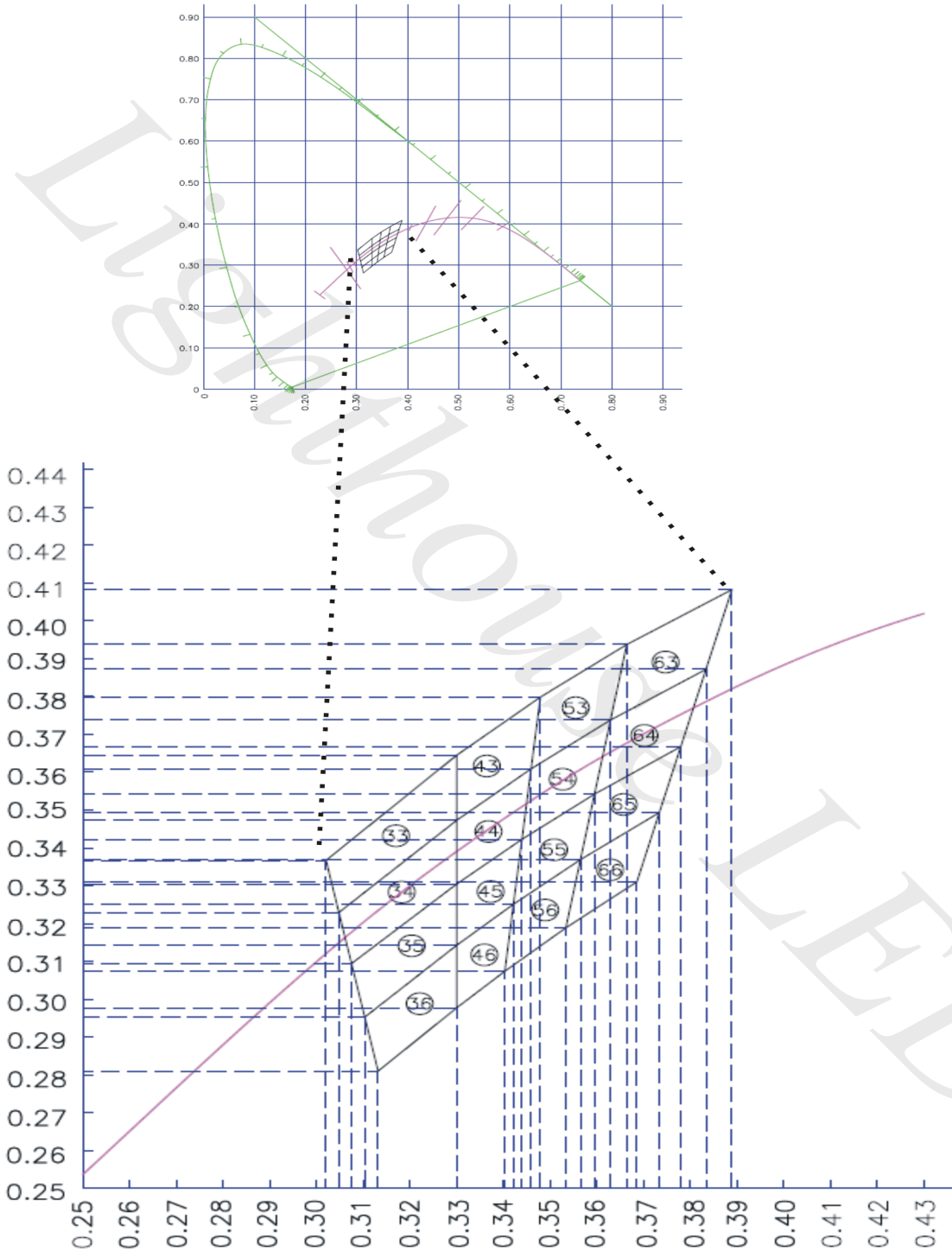

PART NUMBER	REV	PAGE	DATE
XH-P20WB539B10	R101	3/4	2010-09-21

HIGH POWER LED Typical Electro-Optical Characteristics Curves

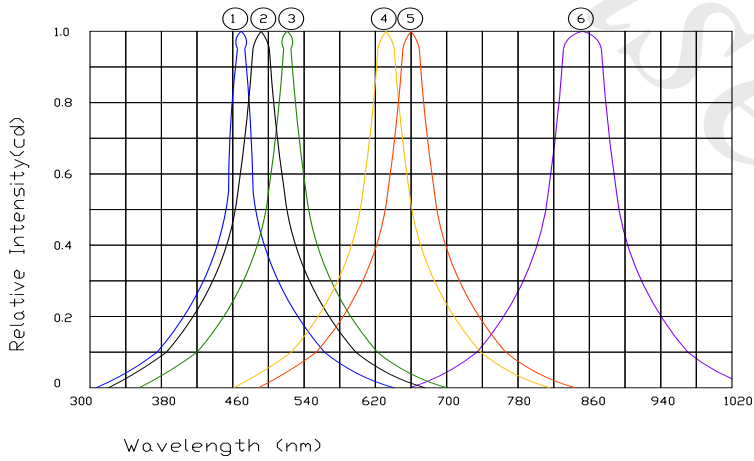
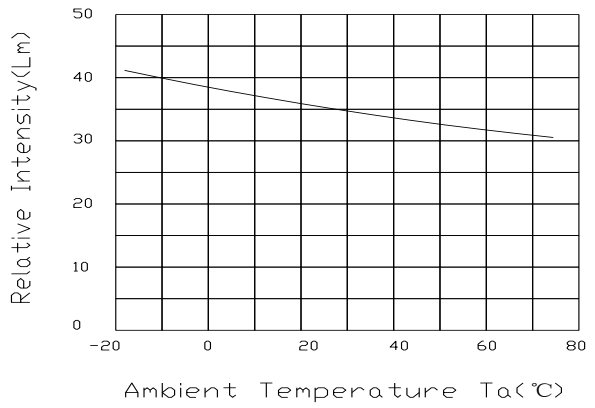
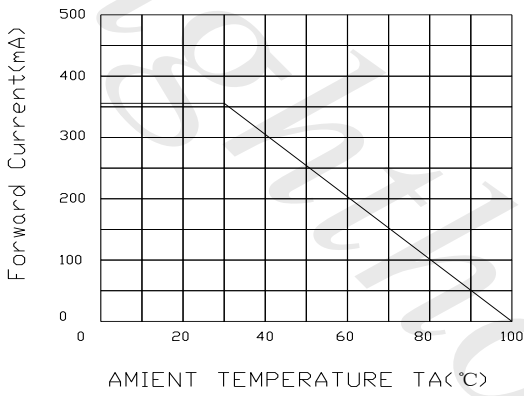
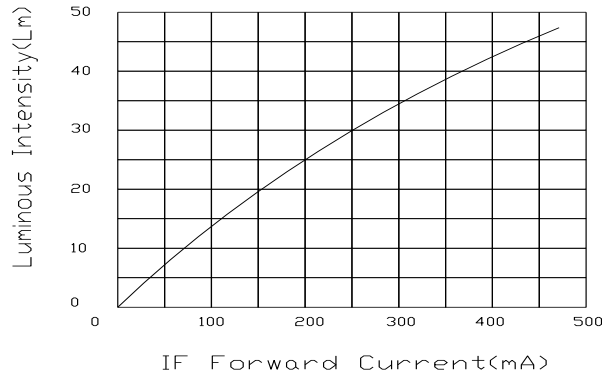
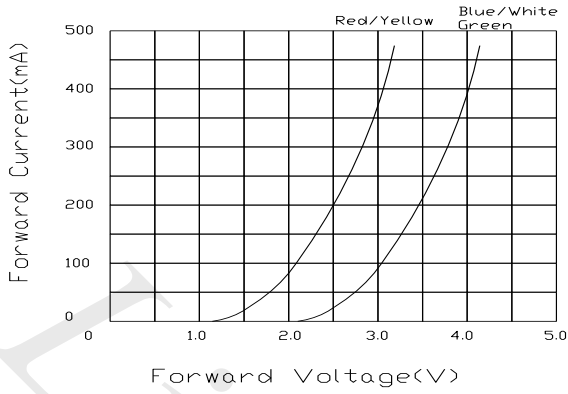

- ① Blue Lamp(InGaN)
- ② White Lamp(InGaN)
- ③ Pure Green Lamp(InGaN)
- ④ Yellow Green Lamp(AlInGaP)
- ⑤ Red Lamp(AlInGaP)
- ⑥ Infrared Lamp(850nm)

PART NUMBER	REV	PAGE	DATE
XH-P20WB539B10	R101	4/4	2010-09-21